

GENERAL NOTES

1. DO NOT SCALE DRAWINGS. WRITTEN DIMENSIONS SHALL HAVE PRECEDENCE OVER SCALED DIMENSIONS.
2. ALL WORK SHALL COMPLY WITH THE 2012 ONTARIO BUILDING CODE AND AMENDMENTS.
3. CONTRACTORS MUST CHECK AND VERIFY ALL DIMENSIONS AND SPECIFICATIONS AND REPORT ANY DISCREPANCIES TO THE ARCHITECT BEFORE PROCEEDING WITH THE WORK.
4. ALL CONTRACTORS AND SUB-CRONTACTORS SHALL HAVE A SET OF APPROVED CONSTRUCTION DOCUMENTS ON SITE AT ALL TIMES.
5. ALL DOCUMENTS REMAIN THE PROPERTY OF THE ARCHITECT. UNAUTHORIZED USE, MODIFICATION, AND/OR REPRODUCTION OF THESE DOCUMENTS IS PROHIBITED WITHOUT WRITTEN PERMISSION. THE CONTRACT DOCUMENTS WERE PREPARED BY THE CONSULTANT FOR THE ACCOUNT OF THE OWNER.
6. THE MATERIAL CONTAINED HEREIN REFLECTS THE CONSULTANT'S BEST JUDGEMENT IN LIGHT OF THE INFORMATION AVAILABLE TO HIM AT THE TIME OF PREPARATION. ANY USE WHICH A THIRD PARTY MAKES OF THE CONTRACT DOCUMENTS, OR ANY RELIANCE ON OR DECISIONS TO BE MADE BASED ON THEM ARE THE RESPONSIBILITY OF SUCH THIRD PARTIES.
7. THE CONSULTANT ACCEPTS NO RESPONSIBILITY FOR DAMAGES, IF ANY, SUFFERED BY ANY THIRD PARTY AS A RESULT OF DECISIONS MADE OR ACTIONS BASED ON THE CONTRACT DOCUMENTS.

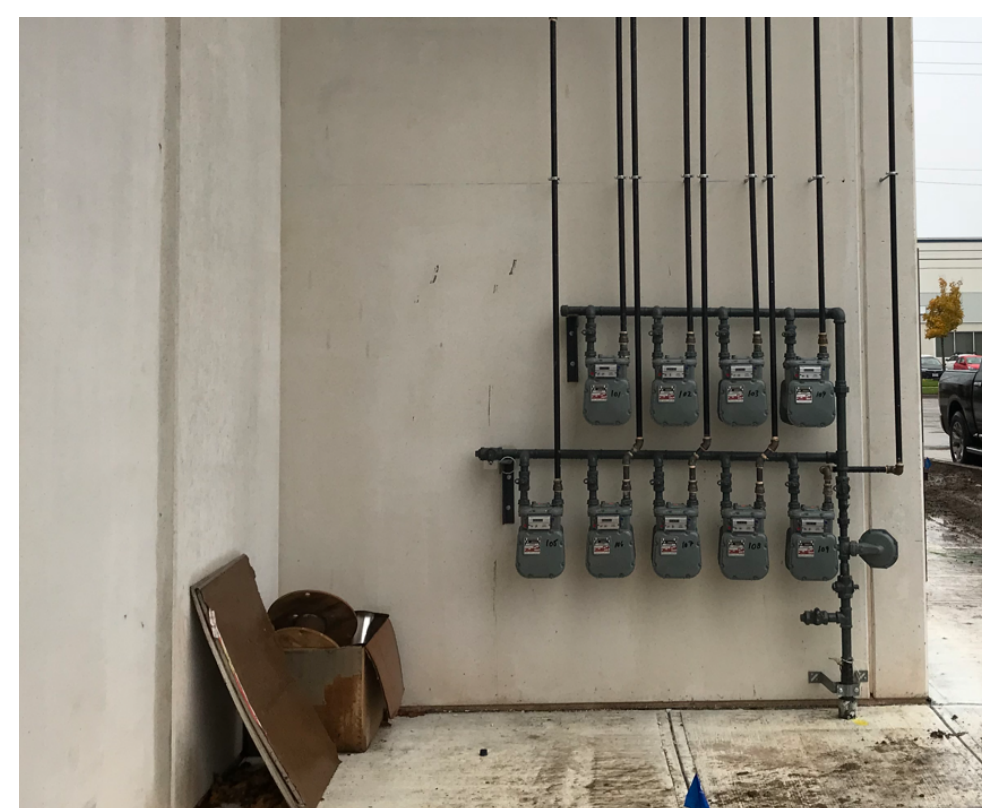

Installation of Gas metes extracted from another project as sample

10 Gas metes
One for each
Townhomes



10 Gas metes
One for each
Townhomes

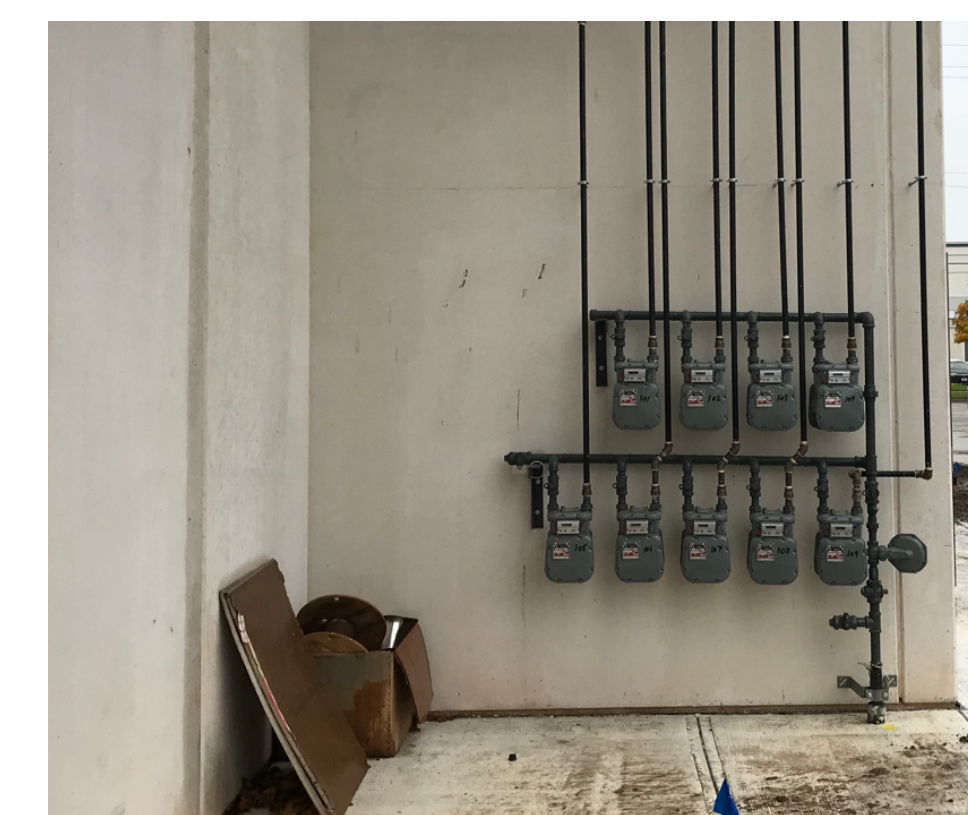

10 Gas metes
One for each
Townhomes

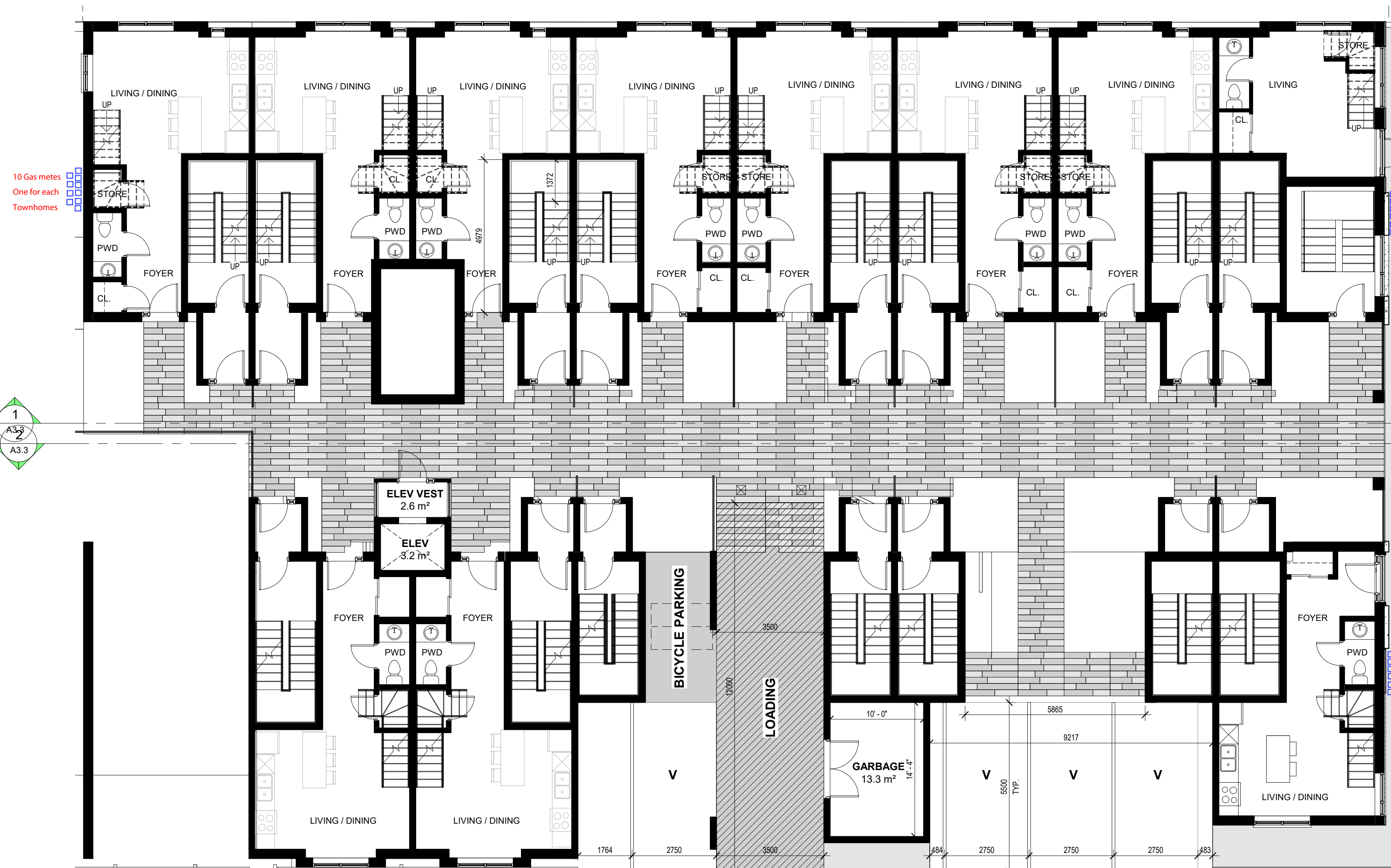

1 FLOOR PLAN - LEVEL 1
1 : 100

No.	Date	Revision
5	2022-04-06	ISSUED FOR REZONING
4	2020-12-16	ISSUED FOR REZONING
3	2020-12-04	Consultant Coordination
2	2020-11-19	Consultant Coordination
1	2020-09-28	Consultant Coordination

Project No.	20052
Project Date	2022-04-06
Drawn by	TJM
Checked by	MYV
Plot Date / Time	2022-04-07 8:59:23 AM



**16 & 18 MILL STREET,
GEORGETOWN
DEVELOPMENT**

LEVEL 1 FLOOR PLANS

Drawing Scale 1 : 100

Status

CLIENT
APPROVAL
Drawing No. Revision No.

A2.3 - r5



METRIS[®] 250

Residential Gas Meter

The METRIS gas meter is constructed uniquely to give utilities the edge they need in an increasingly complex and competitive marketplace. The METRIS offers three versions that provide greater flexibility for your metering needs. The unique modular design of the METRIS offers the advantage of complete customization to fit individual installation needs.

In addition, due to inventory and manufacturing enhancements provided by modularity, this invaluable flexibility also can be delivered with unparalleled speed and scheduling dependability. Itron diaphragm meter products are manufactured at Itron's Owenton, KY, facility where our workers take pride in delivering quality products with the utmost concern for customer satisfaction.

The METRIS gas meter is designed to increase your customer's satisfaction and reduce your total costs by offering modular flexibility and measurement accuracy for residential applications. The METRIS is rated at a full 250 CFH.

TESTING

Itron takes pride in our testing equipment and facilities. All of our calibration instrumentation is NIST traceable. We have an unbroken chain of NIST traceability all the way through each piece of test equipment.

KEY FEATURES

- » Common measurement module
- » 4-chamber design
- » One piece, seamless, convoluted diaphragm
- » Tamper resistant design
- » Built in pressure taps (RM)
- » Lubrication free bearing surfaces

- » Top entry adjustment
- » EZ-VU Adjustment Port
- » 5/16" nut adjustment mechanism
- » Easy handling
- » Long life
- » AMR/AMI Compatible

Meets applicable standards

- » ANSI B109.1

Product approvals

- » Measurement Canada AG-0393
- » CA Weights & Measures 5398-11
- » Maryland Public Service Commission COMAR 20.55.07.02

METRIS 250:

Standard Retrofit Application

- » 6" center-to-center
- » Light weight
- » Flat base for handling stability



METRIS RM:

Total Measurement Application

- » Integral full performance regulator and meter bar
- » Cost saving design
- » Remove meter from service independent of regulator
- » Three pressure taps for field maintenance



METRIS MB:

Sub-Metering Application

- » Back inlet and outlet connections
- » Tight meter sets
- » ¾" or 1" connections



SPECIFICATIONS

	METRIS 250	METRIS RM	METRIS MB
Meter Capacity	250 CFH Natural Gas @ .5 inch w.c. Differential 400 CFH Natural Gas @ 1.0 inch w.c. Differential		
Hub Center-to-Center	6"	N/A	N/A
Hub Sizes	#1 Sprague Standard, 10 LT, 20 LT, 30 LT, 1-¼"		
Inlet Connection	N/A	¾" or 1" Female NPT	
Meter Type	(TC) Temperature Compensated (NTC) Non-Temperature Compensated		
Units	Imperial (Cubic Feet - ft³) Metric (Cubic Meters - m³)		
Index Drive	2 ft³/revolution 50 cubic decimeters/revolution		
Proving / Test Dials	ft³ - ½' and 2' Proving Dials m³ - 10 dm³ and 50 dm³ Proving Dials		
Tangent Crank	14 revolutions/ft³ or .071 ft³/revolution .5 revolutions/dm³ or 2 liters/revolution		
Indexes	4 Circle Dial (ft³ - Standard Pressure, 2 PSIG) 4 Digit Direct Read (ft³ - Standard Pressure) 5 Digit Direct Read (ft³ or m³ - Standard Pressure) Standard = 7 inches w.c. @ 14.73 PSIA base/ 14.4 PSIA atmospheric		
Meter M.A.O.P.	5 PSIG (10 PSIG optional)		
Regulator M.A.O.P.	N/A	125 PSIG	N/A
Meter Operating Temperature Range	-30°F to +120°F -34°C to +49°C		
Surface Treatment	ASA 49 Gray Polyester Powder Coat		

	Meters per Layer	Layers per Pallet	Meters per Pallet	Pallet Dimensions	Pallet Weight (lbs)
METRIS 250	25	4	100	48" x 46" x 52"	950
METRIS 250 with AMR/AMI	20	4	80	48" x 46" x 52"	800
METRIS RM	16	3	48	48" x 46" x 40"	785

All dimensions and weights provided are approximate

INSTALLATION

The METRIS RM offers exactly what the homeowner wants: a clean, simple installation and aesthetics without bulk. The RM solution reduces the number of connections, the amount of piping, and the need to manipulate awkward connection points. As a result, the utility's time and work force investment is reduced.

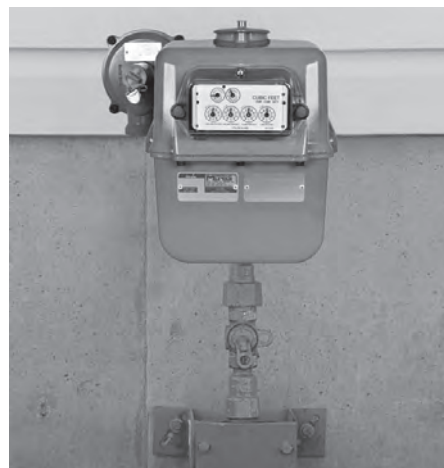

DIMENSIONS

Imperial - Inches

	METRIS 250	METRIS RM	METRIS MB
A	7.7	7.7	7.7
B	11.3	10.0	11.0
C	6.0	2.3	2.3
D	8.8	12.5	12.5
E	6.0	6.0	6.0
F	9.2	12.2	9.2
G	3.8	6.8	6.8
H		5.4	
I		8.5	8.5
J		0.8	0.8
K		2.4	2.4
Wt. (lbs)	9	14.5	13

Metric - Millimeters

	METRIS 250	METRIS RM	METRIS MB
A	196	196	196
B	288	254	279
C	153	58	58
D	224	318	318
E	152	152	152
F	233	310	233
G	96	173	173
H		137	
I		216	216
J		20	20
K		61	61
Wt. (kg)	4.1	6.6	5.9

All dimensions and weights provided are approximate

METRIS 250:

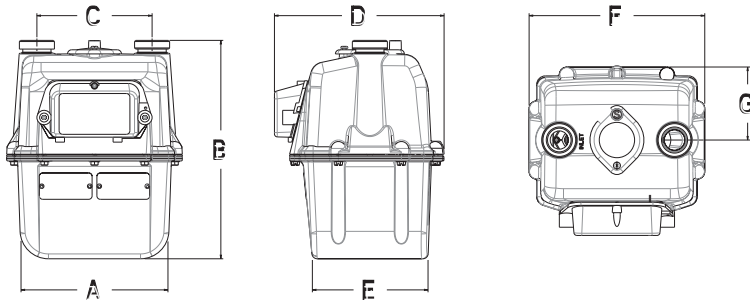

METRIS RM:

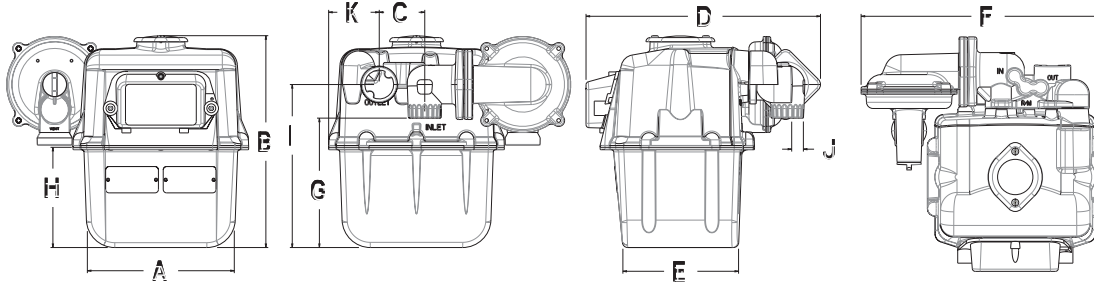

METRIS MB:

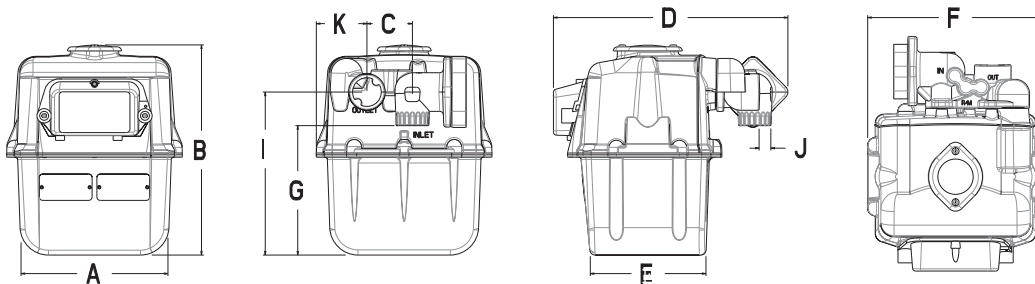

Capacity & pressure loss*

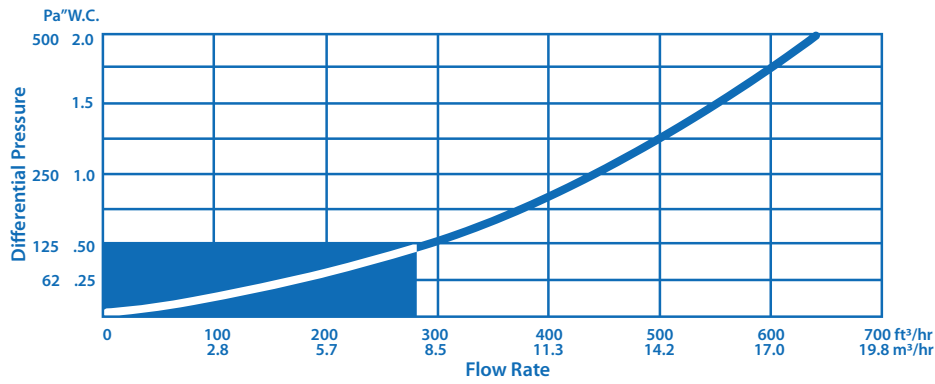

Accelerated life test*

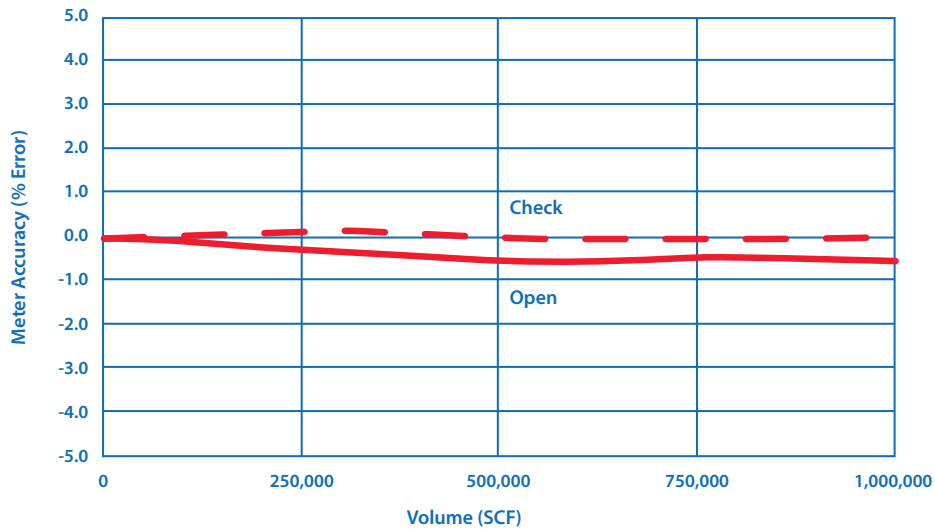

*Individual meter performance may vary from data shown.

AMR/AMI COMPATIBLE

The METRIS 250 is compatible with leading AMR/AMI devices.



METRIS 250 shown with 100G Datalogging Gas ERT® Module

Additional Information

- » METRIS Meter Adjustment (TDC-0847**)
 - » Diaphragm Type Gas Meters Installation Procedure (TDC-0841**)
 - » Diaphragm Meter Product Line (TDC-0858**)
 - » METRIS Parts List (TDC-0913**)
- **Use most current publication revision.



Itron is the world's leading provider of smart metering, data collection and utility software systems, with over 8,000 utilities worldwide relying on our solutions to responsibly and efficiently manage the delivery and use of energy and water. To realize your smarter energy and water future, start here: www.itron.com

ITRON GAS METERING

970 Highway 127 North
Owenton, Kentucky 40359
USA

Phone: 1.800.490.0657
Fax: 1.502.484.6223

CORPORATE HEADQUARTERS

2111 N Molter Road
Liberty Lake, WA 99019
USA

Phone: 1.800.635.5461
Fax: 1.509.891.3355